

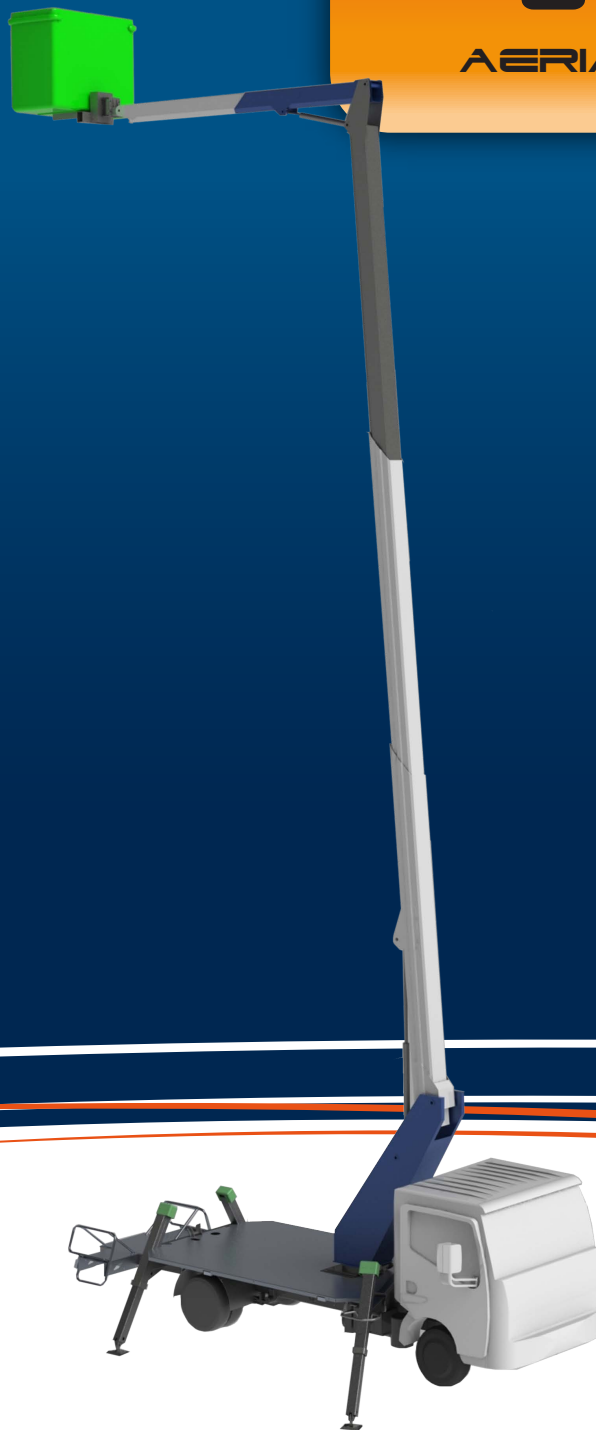

**GT 20 J**  
**AERIAL PLATFORM**



# M Telescopic Range GT 20 J

REV. 10/2015

**3.5 t**  
7716 lbs

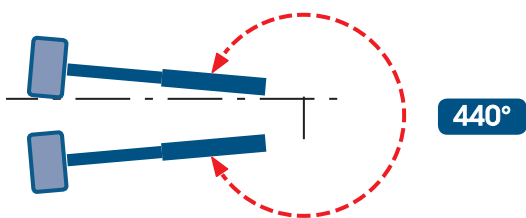
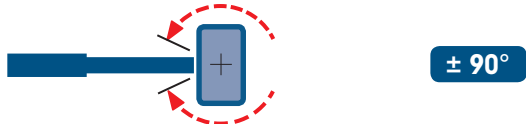
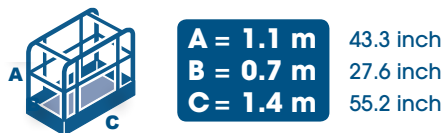
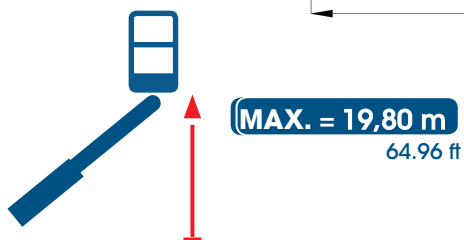
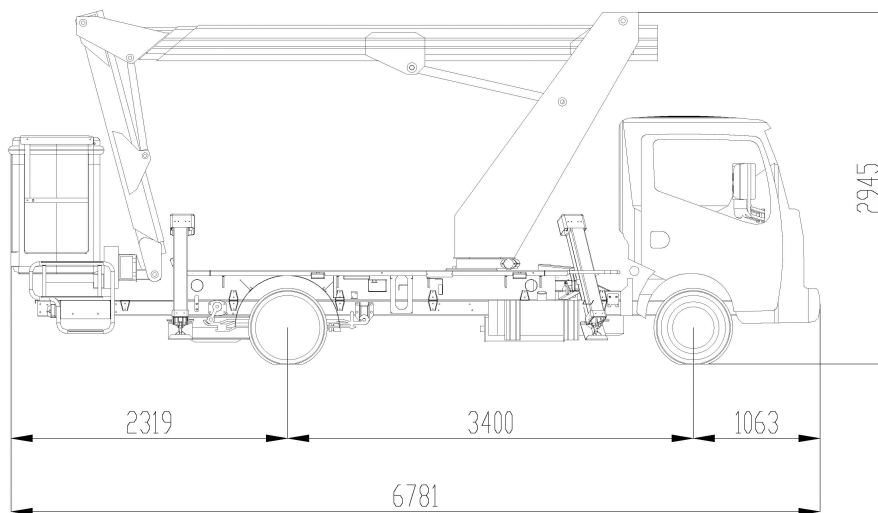

**ELECTRO HYDRAULIC  
PROPORTIONAL**

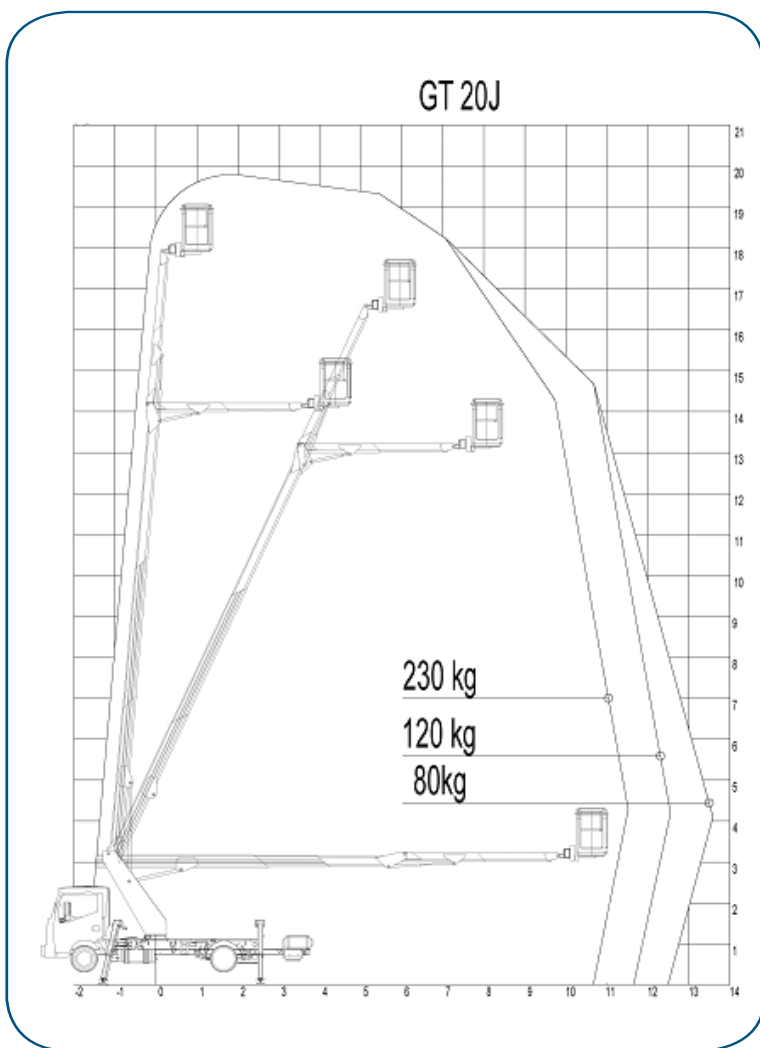

**GT 20 J**

**AERIAL PLATFORM**

**Manotti S.r.l.**

Via D. Marchesi, 2/b — 42022 Boretto (RE) Italy  
Tel. +39 0522 965590 — Fax +39 0522 015169  
info@manotti.eu — sales@manotti.eu  
www.manotti.eu